

CM-680

Monitor / Crossover

INSTRUCTION MANUAL

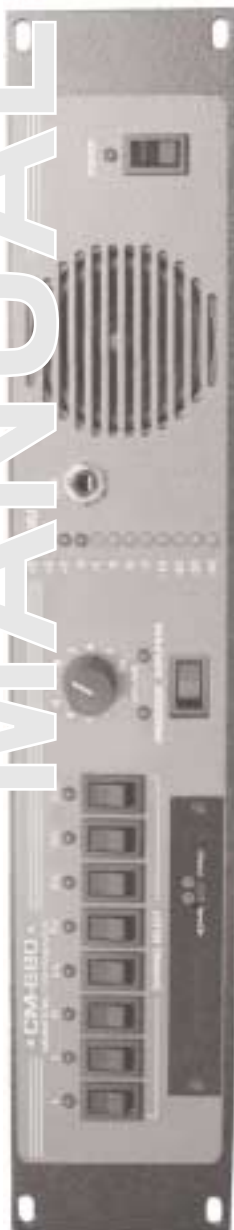

 **USL, Inc.**
Quality Cinema Products

181 Bonetti Drive
San Luis Obispo, CA 93401
ph: 805-549-0161
fax: 805-549-0163
e-mail: usl@uslinc.com

One Year Limited Warranty



USL, Inc. warrants that each product manufactured by it will be free from defects in material and workmanship under normal usage for a period of one (1) year after its purchase new from an authorized dealer. Our obligation under this warranty is limited to repairing or replacing any product or component which we are satisfied does not conform with the foregoing warranty and which is returned to our factory, freight paid, or serviced by one of our authorized contractors. The foregoing warranty is exclusive and in lieu of all other warranties, whether expressed or implied. Such warranty shall not apply to any product or component (A) repaired or altered by anyone other than USL, Inc. or an authorized service contractor; (B) tampered with or altered in any way or subjected to misuse, negligence or accident or (C) which has been improperly connected installed or adjusted other than in accordance with USL, Inc.'s instruction.

Table of Contents

Introduction3
Front & Rear Panel Description.....5
Installation.....7
Crossover Setup.....11

Please record the following information for your records:
Model: _____ Serial Number: _____
Date of Purchase: _____ Purchased from: _____

Introduction

Please read this entire manual before commencing your installation.

The Ultra★Stereo CM-680 Projection Booth Monitor has been designed for high performance, ease of use, and years of trouble free service. Installation and setup of the monitors has been considerably simplified. No special tools are required. The built in VU meter and test jack give the technician immediate information about the status of the processor and all power amplifiers. All controls necessary for daily operation of the processor are easily accessible on the front panel. The components that make up the CM-680 monitors are of computer grade for reliability. All front panel controls are individually sealed for long life. All Ultra★Stereo equipment has been “burned-in” at the factory for an extended period in order to eliminate the possibility of premature failure. Unpack the unit carefully. If the container has been damaged, thoroughly inspect the equipment to make certain that there is no hidden damage. File a claim immediately with the carrier if any damage is found. Also advise your dealer or the factory.

TOOLS REQUIRED

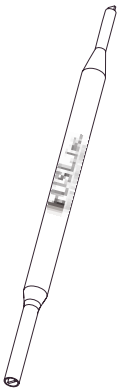

Trimpot
adjustment
tool

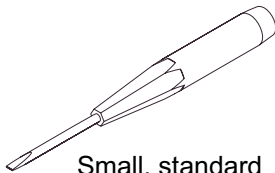

Small, standard
screwdriver

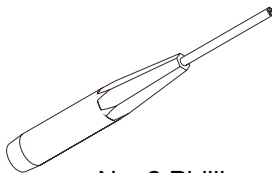

No. 2 Phillips
screwdriver

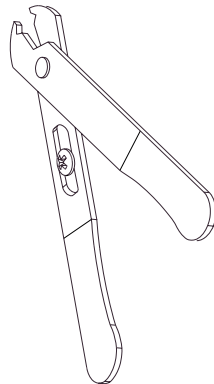

Wire
Strippers

You will need to supply the following materials:

- Shielded audio cable for connecting the CM-680 to the cinema processor and power amplifier outputs.
- Four 10-32 x 1/2" screws to mount the CM-680 in the audio equipment rack.

FEATURES**The CM-680 monitor has the following standard features:**

- Eight-Channel Monitoring - allows you to monitor either the processor or power amplifier outputs to left, center, right, surround left, surround right, back surround left, back surround right and subwoofer channels, in any combination via the switch on the front panel (see illustration on pg. 5 - switch 5)
- Input levels from processor and power amplifier can be adjusted independently - no huge level jumps when switching between processor and power amplifiers.
- Bargraph display may be calibrated to the reference level for your theatre – the projectionist can see auditorium levels instantly.
- Designed to work with bi-amplified sound systems to monitor the high and low frequency outputs from the left, center and right channels.

CM-680 Front Panel **Figure 1**

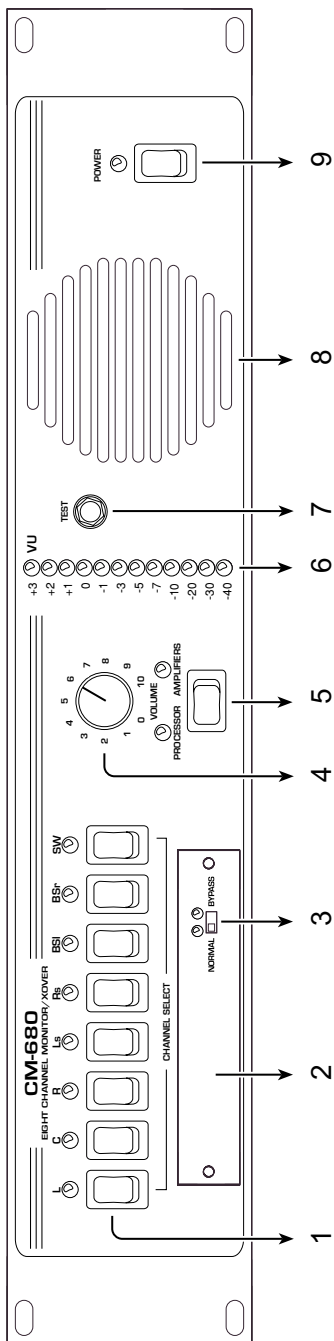

1. Channel select buttons - pressing a Channel Select Button causes the corresponding LED to illuminate and the signal from that channel to be monitored. Any combination of eight channels can be selected.
2. Internal Digital or Analog Crossover Access Cover.
3. Crossover Bypass Switch - Switching this will cause the internal crossover to be bypassed or engaged and the condition will be indicated by its appropriate LED.
4. Volume Control - controls the volume of the internal or external speaker. The volume control has no effect on the VU Bargraph display.
5. Processor/Amplifier Selector Switch - selects either the inputs from the cinema processor or power amplifiers for monitoring.
6. VU Bargraph - displays the level of the selected channels. The VU Bargraph may be calibrated by the rear panel trim adjustment (Figure 2). The VU Bargraph operates independently of the volume control (4).
7. Test Jack - permits monitoring of the audio output of the CM-680. Inserting a mono or stereo 1/4" phone plug here disables the internal speaker and routes the audio output to the Test Jack. Do not connect any device here with less than 8 Ohms impedance.
8. Internal Speaker
9. Power Switch

Installation

Mount the CM-680

The ideal place for the CM-680 Monitor is in the sound rack or projector console between the stereo processor and power amplifiers. DB25 and HD15 connectors are available on the back plane to make installation quick and easy. Alternatively, terminal blocks allow the use of stripped and tinned wire. They are pluggable for easy service and trouble shooting.

Monitor Hookup

1. Power: Connect the unit to the AC power outlet using the standard IEC cable provided. Any power source from 100-300VAC, 50-60 Hz will be sufficient.

2. Monitor Inputs From Processor Outputs: Use the male-female 25 pin D cable to connect the output of the cinema processor to the main input of the CM-680. If "EX" channels are to be used, then plug an additional male-female 25 pin D cable from the "Optional Outputs" at the processor to the "Optional Inputs" of the CM-680.

NOTE: you must select "EX" or NORMAL (non "EX") channel routing using the DIP switches on the rear panel of the CM-680.

3. Crossover Outputs to Power Amplifier Inputs: The CM-680 utilizes HD15 connectors that mate with several popular amplifiers. Plug one end of the "VGA" HD15 cable into the chassis connector on the rear of the CM-680. Plug the other end of the cable into the appropriate amplifier. The VGA cable not only sends the CM-680 crossover signal to the amplifiers, but also sends a power amp output signal back to the CM-680 monitor. This vastly simplifies rack wiring. USL, Inc. stocks 2', 4' and 6' long VGA cables. See figure #3

Terminal blocks are also provided on the back of the CM-680 chassis to allow wiring to traditional amplifiers without the HD15 interface. All crossover outputs are balanced. Please use two conductor shielded cable to minimize ground loops and hum. Connect each of the crossover channel outputs to the appropriate amplifier inputs.

4. Monitor Inputs From Power Amplifier Outputs: *When VGA cables are NOT being used, the amplifier outputs must be connected to terminal blocks 2 & 3.* Unshielded wire can be used to connect the output of the amplifiers to the appropriate monitor speaker. Inputs on the rear panel of the CM-680: All of these inputs are unbalanced except for the subwoofer. See figure #2

Figure 3 SIMPLE WIRING DIAGRAM WITH HD-15 CONNECTORS

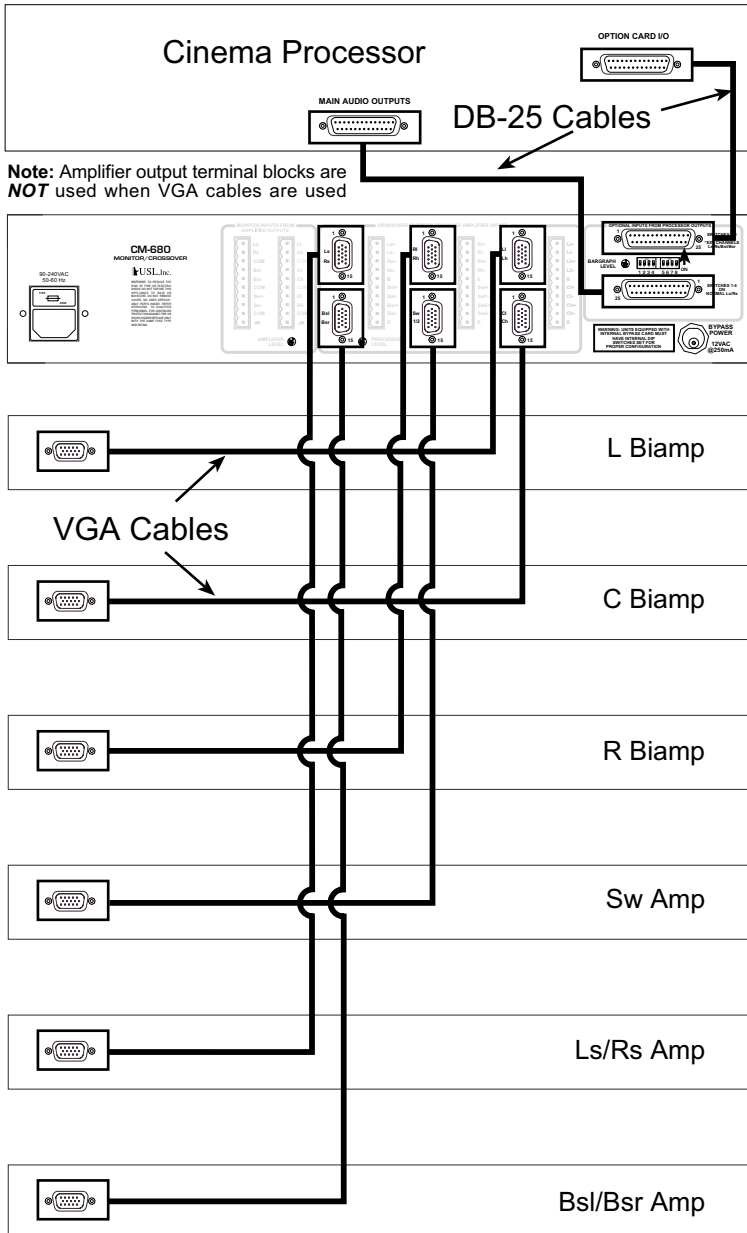

Setting Monitor and Bargraph Levels:

Set the processor main fader and amplifier levels so the house speakers are playing back at the normal listening level. Select some source material like pink noise.

Set the "Processor/Amplifier" switch to "Processor". With the monitor volume to "7", adjust the "Processor" trimpot for a comfortable listening level. Set the bargraph trimpot for a reading in the middle range.

Set the "Processor/Amplifier" switch to "Amplifier", adjust the amplifier trimpot so the level matches the processor level.

DB-25 Connector Pinout

**Main
Processor
Outputs**

**Optional
Processor
Outputs**

Pin #	Function	Function
1	GND	N/C
2	L +	N/C
3	N/C	Bsl -
4	GND	N/C
5	C +	Ch +
6	N/C	Bsr -
7	GND	GND
8	R +	Rh +
9	GND	N/C
10	LS -	Ls -
11	RS -	Rs -
12	SW -	Lh -
13	GND	N/C
14	L -	N/C
15	N/C	N/C
16	N/C	Bsl +
17	C -	Ch -
18	N/C	N/C
19	N/C	Bsr +
20	R -	Rh -
21	N/C	N/C
22	GND	N/C
23	LS +	Ls +
24	RS +	Rs +
25	SW +	Lh +

Figure 5

CM-680 HD 15 pin outs

Typical per connector

Pin #	Name	Pin #	Name	Pin #	Name
1	Band A (1), - Signal	6	Chassis Gnd	11	Band B (2), - Signal
2	NC	7	Band A (1), + Signal	12	NC
3	Band A, Vmon (Amp returns)	8	Band B (2), + Signal	13	Band B, Vmon (Amp returns)
4	Band A, Imon	9	NC	14	Band B, Imon
5	NC	10	Signal Ground	15	NC

Crossover Setup

Analog Crossover Card XTA-680: When using the USL, Inc. Crossover card, the following parameters must be set: time delay, crossover frequency, horn EQ, Screen EQ and output levels. See figure #6.

Make sure the NORMAL/BYPASS switch is set in the NORMAL position.

Determine the model number of the speaker system being used. (Figure #7 has a listing of several popular cinema loudspeakers.)

If your loudspeaker requires a 1.8 ms delay, turn "ON" all DIP switches on the first row marked 1.8 ms. Refer to figure #7. Likewise a loudspeaker requiring 1.4 ms delay should require all the DIP switches in the second row to be turned "ON".

For loudspeakers requiring only 0.7 ms delay, leave all the time delay DIP switches "OFF". **Never turn on both rows of time Delay switches!**

Next, set the crossover frequency. For 800Hz, turn all the crossover frequency DIP switches in the first row "ON". For 500Hz, turn all the DIP switches in the second row "ON". For 330Hz, turn all the DIP switches in the third row "ON". For 297 Hz, leave all the crossover frequency DIP switches "OFF". **Never turn on more than one row of DIP switches.**

Now, set the horn EQ and screen EQ DIP switches. Generally, all six DIP switches should be "ON". In some cinemas, the left and right speakers are mounted outside the screen area. In this case, turn the left and right screen EQ switches to "OFF". Some high frequency horns are very flat to 20kHz. In this case, you may want to turn the horn EQ switches to "OFF". The horn and screen EQ each provide about 8dB of boost at 20kHz. The combination of horn and screen EQ results in about 16 dB boost at 20kHz.

Finally, set the output levels. Using a Real Time Analyzer and feeding a pink noise signal from the cinema processor, set the appropriate ten turn pots for a flat response around the crossover frequency and a total SPL level of "85" on each of the front three channels. There should be enough range in the output pots to allow setting the amplifier gains at maximum or at the 12 O'clock position.

The bypass crossover is fixed at about 500 Hz with no time delay. Using a Real Time Analyzer and feeding pink noise from the center channel of the cinema processor, set the bypass levels for flat response around 500 Hz and an SPL level of 85. The NORMAL/BYPASS switch will need to be set in BYPASS.

Figure 6

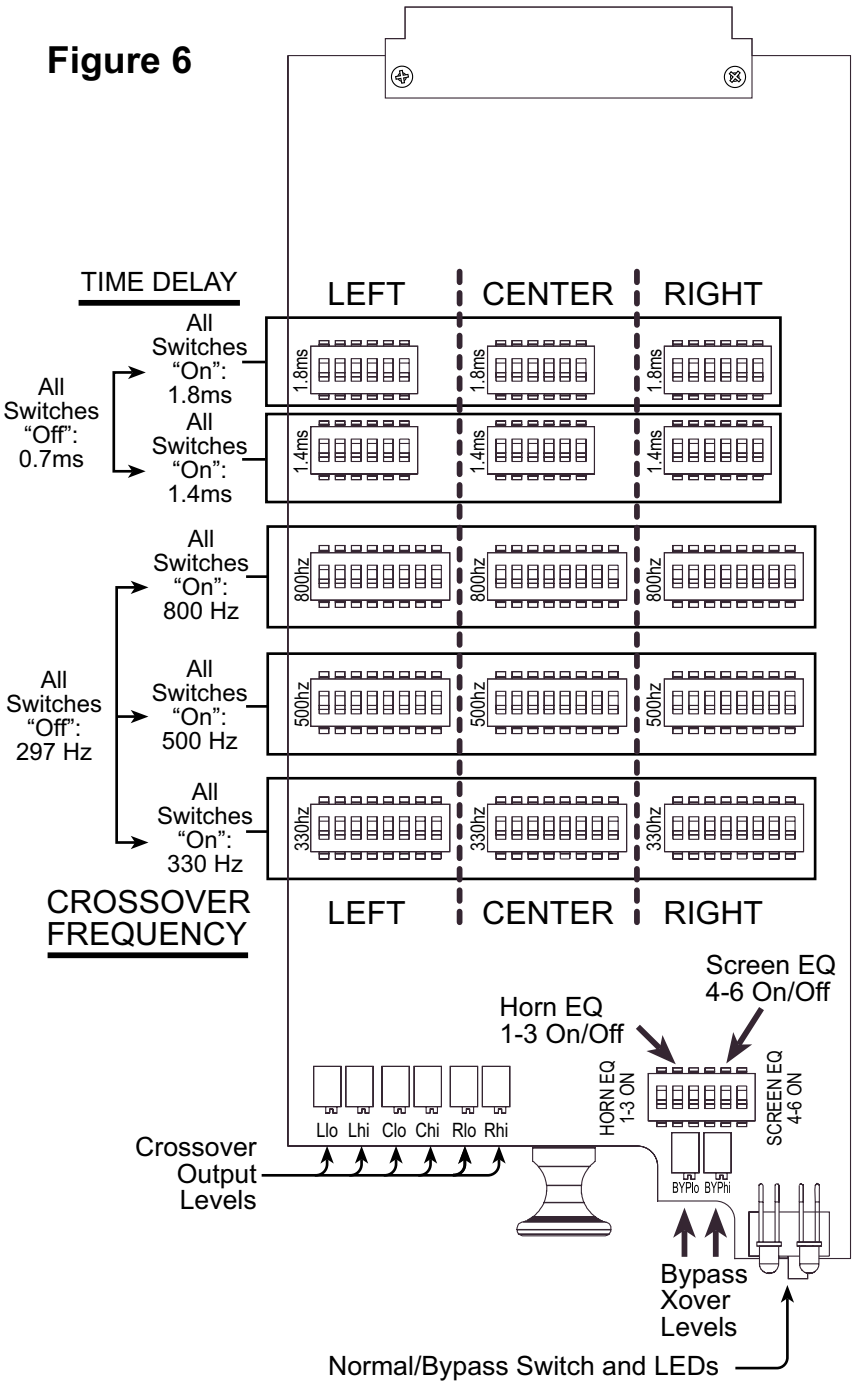
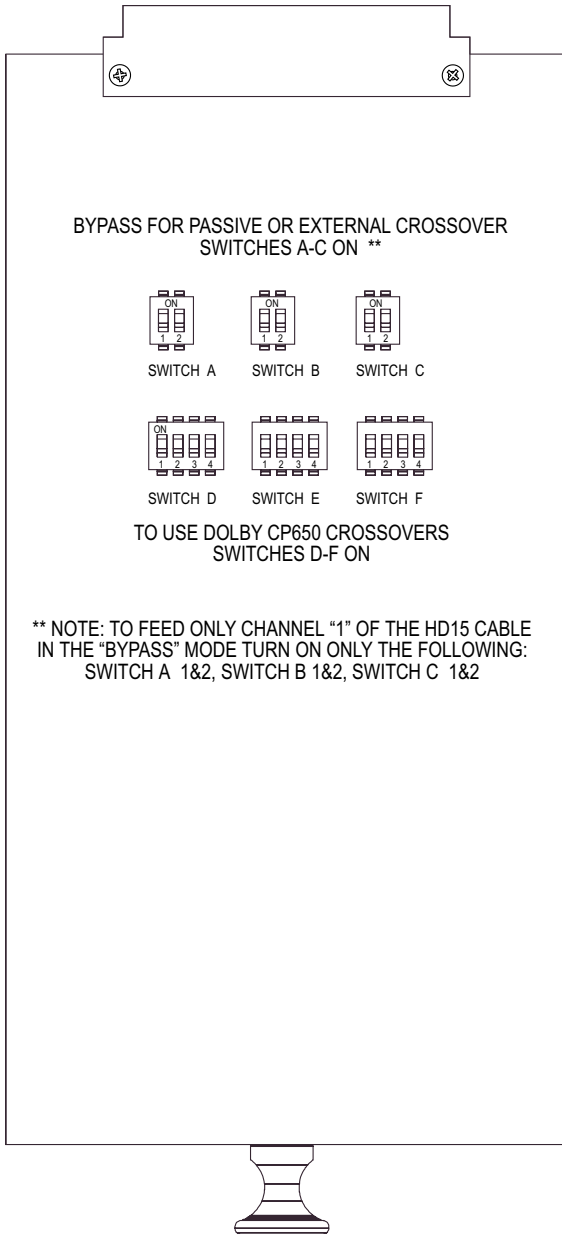

Figure 7

<u>Speaker</u>	<u>Crossover Frequency</u>	<u>Time Delay</u>
JBL 4675D	500Hz	1.8ms.
JBL 4670	800Hz	0.7ms,
JBL 5671	330Hz	1.4ms
JBL 5672	297Hz	1.8ms.
JBL 5674	297Hz	1.8ms
EV TS940	800Hz	0.7ms.
EV TS992LX	500HZ	1.8ms.
EV 9040	500Hz	1.8ms
EV Variplex	330Hz	1.4ms
EAW CB2591	500Hz	1.8ms
EAW CB259	800Hz	0.7ms
EAW CB253	350	0.7ms

1. Bypass Card XTB-680: When using external crossovers, the CM-680 must be equipped with a bypass card in the crossover slot. For connection to a CP-650, slide dip switches D,E, & F on the XTB-680 to the "ON" position. When using other electronic crossovers or speakers with passive crossovers, turn DIP switches A,B & C to "ON". See figure #8 Connect crossover inputs to rear of CM-680 at LI, CI &RI as per Fig.4 (Page9)

Figure 8



Specifications

Inputs

Processor: Eight inputs corresponding to left, center, right, surround left, surround right, back surround left, back surround right and subwoofer. Input impedance is 10k Ω .

Power Amplifiers: Eleven inputs corresponding to left hi and lo, center hi and lo, right hi and lo, surround left, surround right, back surround left, back surround right and subwoofer. Input impedance is greater than 50K

Controls

Front Panel: Individual push button switches for each input channel toggle on and off so that channels may be monitored in any combination. An LED indicator illuminates when the corresponding channel is selected. A volume control sets the speaker output level and works independently of the front panel VU bargraph meter. A push-button switch with corresponding LED switches monitoring between the Processor and Amplifier inputs. A 12-segment bargraph VU Meter indicates the input level from -40 to +3 VU.

Rear Panel: Three trimpots adjust the processor, amplifier and VU meter input levels.

Power Requirements

100-300VAC, 50-60Hz, 32 Watts

Construction

The CM-680 Monitor is constructed of steel to minimize hum pickup and noise radiation. The overall size of the unit is 3.5" x 19" x 9.625". The CM-680 is designed to mount in a standard rack frame or cabinet.

CM-680

Weight: 10 lbs. 2 oz. (4.63 kg)

Shipping weight: 16 lbs. (7.26kg)

Shipping Size: 22" x 22" x 6" (558.8 x 558.8 x 152.4 mm)



181 Bonetti Drive, San Luis Obispo, CA 93401
ph: 805-549-0161 fax: 805-549-0163
e-mail: usl@uslinc.com

© 2002 All Rights Reserved
7/25/02